



SD6AW220/230 -HNI

2Mp Full HD Network Auto-Tracking IR Wipe PTZ Dome Camera

Included :



+



220 VAC / 24 VAC



Features

- Powerful 20x/30x optical zoom
- H.264 & MJPEG Three-stream encoding
- Max 60fps@720P and 30fps@1080P resolution
- Defog, DWDR, Day/Night(ICR), Ultra DNR, EIS, Auto iris, Auto focus
- Support Wipe
- Multiple network monitoring: Web viewer, CMS(DSS/PSS) & DMSS
- Max 240°/s pan speed, 360° endless pan rotation
- Up to 255 presets, 5 auto scan, 8 tour, 5 pattern
- Built-in 7/2 alarm in/out
- Support Auto tracking and IVS
- Support intelligent 3D positioning with DH-SD protocol
- Micro SD memory, IP66
- IR Distance up to 150m

DH-SD6AW220/230 -HNI

Technical Specifications

| Model | DH-SD6AW220-HNI | DH-SD6AW230-HNI |
|--------------------------|--|-----------------------------------|
| Camera | | |
| Image Sensor | 1/2.8" Exmor CMOS | |
| Effective Pixels | 1944(H) x 1092(V), 2 Megapixels | |
| Scanning System | Progressive | |
| Electronic Shutter Speed | 1/1 ~ 1/30,000s | |
| Min. Illumination | Color: 0.05Lux@F1.6; B/W: 0.005Lux@F1.6 | |
| S/N Ratio | More than 50dB | |
| Video Output | BNC(1.0Vp-p/75Ω), PAL / NTSC | |
| Camera Features | | |
| Day/Night | Auto(ICR) / Color / B/W | |
| Backlight Compensation | BLC / HLC / DWDR (Digital WDR) | |
| White Balance | Auto, ATW, Indoor, Outdoor, Manual | |
| Gain Control | Auto / Manual | |
| Noise Reduction | Ultra DNR (2D/3D) | |
| Privacy Masking | Up to 24 areas | |
| Digital Zoom | 16x | |
| Defog | On / Off | |
| Wipe | Support | |
| Lens | | |
| Focal Length | 4.7mm~94.0mm (20x Optical zoom) | 4.3mm~129mm (30x Optical zoom) |
| Max Aperture | F1.6 ~ F3.5 | F1.6 ~ F4.7 |
| Focus Control | Auto / Manual | |
| Angle of View | H: 55.4° ~ 2.80° | H: 65.1° ~ 2.34° |
| Close Focus Distance | 10mm~ 1000mm | 10mm~ 1200mm |
| PTZ | | |
| Pan/Tilt Range | Pan: 0° ~ 360° endless; Tilt: -10° ~ 90°, auto flip 180° | |
| Manual Control Speed | Pan: 0.1° ~ 200° /s; Tilt: 0.1° ~ 120° /s | |
| Preset Speed | Pan: 240° /s; Tilt: 200° /s | |
| Preset | 80(DH-SD), 255(Pelco-P/D) | |
| PTZ Mode | 5 Pattern, 8 Tour, Auto Pan, Auto Scan | |
| Speed Setup | Human-oriented focal length/ speed adaptation | |
| Power up Action | Auto restore to previous PTZ and lens status after power failure | |
| Idle Motion | Activate Preset/ Pan/ Scan/ Tour/ Pattern if there is no command in the specified period | |
| Time Task | Auto activation of Preset/ Pan/ Scan/ Tour/ Pattern by preset-time | |
| Protocol | DH-SD (Auto recognition) | |
| IR Distance | 150m (2 near IR LED+ 8 far IR LED) | |

DH-SD6AW220/230 -HNI

| Video | | |
|-----------------------------|--|---|
| Compression | H.264 / MJPEG | |
| Resolution | 1080P(1920×1080) / 720P(1280×720) / D1(704×576/704×480) / CIF (352×288/352×240) | |
| Frame Rate | Main Stream | 1080P (1 ~ 25/30fps) / 720P(1~50/60fps) |
| | Sub Stream | D1/CIF(1 ~ 25/30fps) |
| Bit Rate | H.264: 56K ~ 8192Kbps, MJPEG: 56K ~ 20480Kbps | |
| Audio | | |
| Compression | G.711a / G.711u(32kbps)/ PCM(128kbps) | |
| Interface | 1/1 channel In/Out | |
| Intelligent Function | | |
| Auto Tracking | Single-scene, multiple-scene, panorama-scene | |
| IVS | Tripwire, Cross Warning Zone, Perimeter Protection, Loitering Detection, Abandoned Object Detection, Missing Object Detection, Illegal Parking, Fast Moving and etc. | |
| Tracking Trigger Mode | Manual / Auto (alarm triggered) | |
| Tracking Trigger Event | Targeting, Zoom, Tracking, Recording, Snapshot, Alarm and etc. | |
| Network | | |
| Ethernet | RJ-45 (10/100Base-T) | |
| Protocol | IPv4/ IPv6, HTTP, HTTPS, SSL, TCP/IP, UDP, UPnP, ICMP, IGMP, SNMP, RTSP, RTP, SMTP, NTP, DHCP, DNS, PPPOE, DDNS, FTP, IP Filter, QoS, Bonjour, 802.1x | |
| ONVIF | ONVIF Profile S | |
| Max. User Access | 20 users | |
| Smart Phone | iPhone, iPad, Android, Windows Phone | |
| Auxiliary Interface | | |
| Memory Slot | Micro SD, Max 64GB | |
| Alarm | 7/2 channel In/Out | |
| General | | |
| Power Supply | AC 24V/3A (±16%) | |
| Power Consumption | 20W, 43W (IR on, Heater on) | |
| Working Environment | -40°C ~ 70°C / Less than 90% RH | |
| Ingress Protection | IP66 | |
| Dimensions | Φ252(mm) x 385 (mm) | |
| Weight | 6.75kg | |

DH-SD6AW220/230 -HNI

Dimensions (mm)

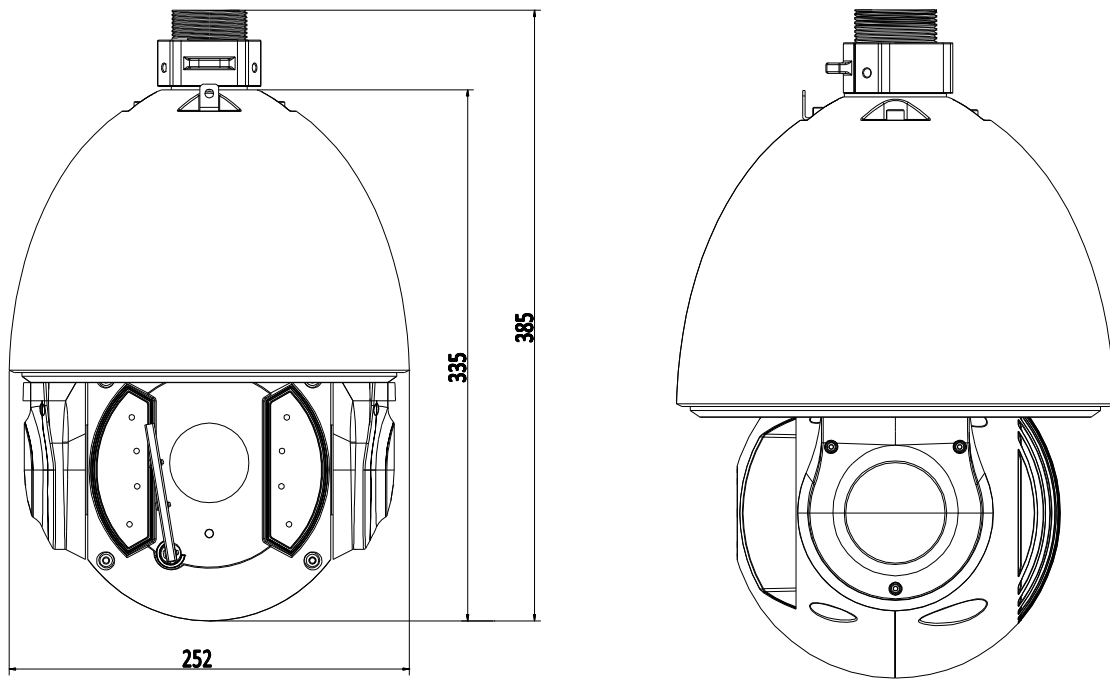







Accessories

| | | |
|---|---|---|
|  |  |  |
| DH-69FB | DH-PFA111 | Power Supply |

DH-SD6AW220/230 -HNI

Accessories (Optional)

| | | | |
|---|---|--|---|
|  |  |  |  |
| DH-PFB300C | DH- PFB301C | DH-PFA112 | DH-PFA113 |
|  |  |  | |
| DH- PFA120 | DH-PFA150 | DH-PFA151 | |

Dahua Technology Co., Ltd.

1199 BinAn Road, Binjiang District, Hangzhou, China

Tel: +86-571-87688883

Fax: +86-571-87688815

Email: overseas@dahuatech.com

www.dahuasecurity.com

*Design and specifications are subject to change without notice.

© 2014 Dahua Technology